

# P1500

Advanced™ Series **PLASTIC** Pumps

# EOM

Engineering  
Operation &  
Maintenance



Advance your process

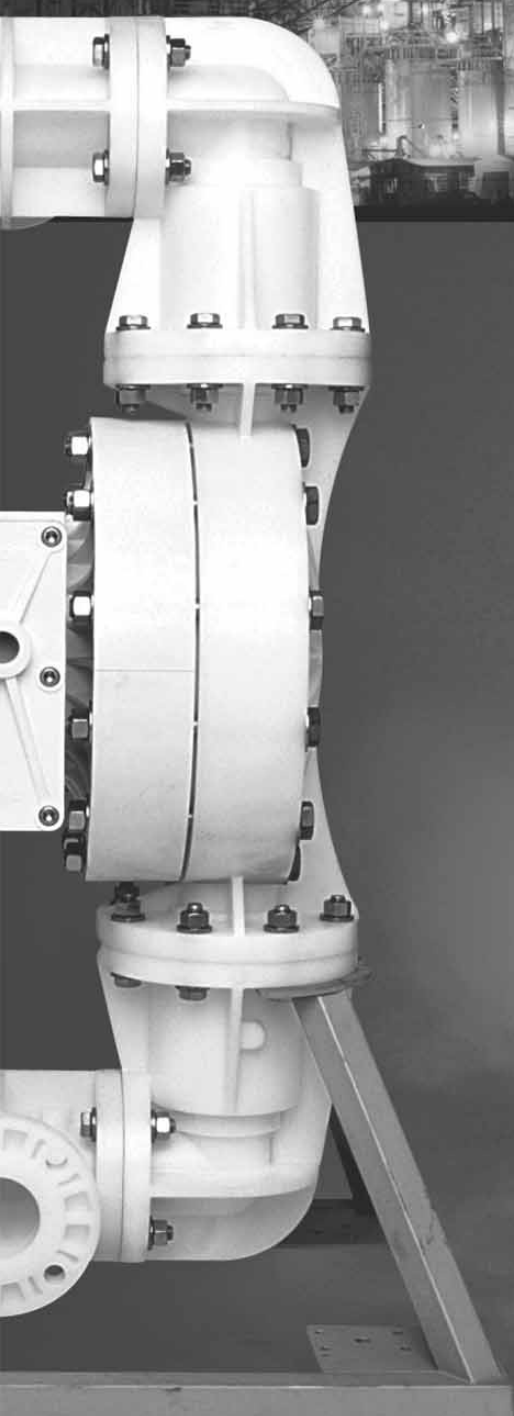

**PRO-FLO**<sup>®</sup>  
PROGRESSIVE PUMP TECHNOLOGY

# WILDEN<sup>®</sup>

A **DOVER** COMPANY



WIL-11160-E-03  
REPLACES WIL-11160-E-02

# TABLE OF CONTENTS

---

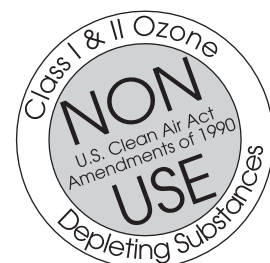

	PAGE #
<b>SECTION 1 – CAUTIONS</b> .....	1
<b>SECTION 2 – PUMP DESIGNATION SYSTEM</b> .....	2
<b>SECTION 3 – HOW IT WORKS (PUMP &amp; AIR SYSTEMS)</b> .....	3
<b>SECTION 4 – DIMENSIONAL DRAWING</b>	
A. P1500 ADVANCED™ PLASTIC .....	4
<b>SECTION 5 – PERFORMANCE CURVES</b>	
A. P1500 ADVANCED™ PLASTIC PTFE-Fitted .....	5
<b>SECTION 6 – SUCTION LIFT CURVE &amp; DATA</b> .....	5
<b>SECTION 7 – INSTALLATION AND OPERATION</b>	
A. Installation.....	6
B. Operation and Maintenance .....	7
C. Troubleshooting.....	8
<b>SECTION 8 – DIRECTIONS FOR DISASSEMBLY/REASSEMBLY</b>	
A. P1500 ADVANCED™ PLASTIC Disassembly/Reassembly .....	9
B. Pro-Flo® Air Valve/Center Block — Disassembly, Cleaning, Inspection.....	12
C. Reassembly Hints & Tips.....	14
<b>SECTION 9 – EXPLODED VIEW/PARTS LISTING</b>	
A. P1500 ADVANCED™ PLASTIC Air Distribution System .....	16
B. P1500 ADVANCED™ PLASTIC Liquid Path.....	18



















## SECTION 1

# P1500 ADVANCED™ PLASTIC CAUTIONS – READ FIRST!

---

-  **CAUTION:** Do not apply compressed air to the exhaust ports — pump will not function.
-  **CAUTION:** Do not over-lubricate air supply — excess lubrication will reduce pump performance. Pump is pre-lubed with NLGI Grade 2 white EP grease.
-  **TEMPERATURE LIMITS:**

Polypropylene	4.4°C to 79°C	40°F to 175°F
PVDF	-12°C to 107°C	10°F to 225°F
PTFE	4.4°C to 104.4°C	40°F to 220°F
-  **CAUTION:** When choosing pump materials, be sure to check the temperature limits for all wetted components. Example: PTFE has a maximum limit of 104°C (220°F) but polypropylene has a maximum limit of only 79°C (175°F).
-  **CAUTION:** Maximum temperature limits are based upon mechanical stress only. Certain chemicals will significantly reduce maximum safe operating temperatures. Consult engineering guide for chemical compatibility and temperature limits.
-  **CAUTION:** Always wear safety glasses when operating pump. If diaphragm rupture occurs, material being pumped may be forced out air exhaust.
-  **WARNING:** Prevention of static sparking — If static sparking occurs, fire or explosion could result. Pump, valves, and containers must be properly grounded when handling flammable fluids and whenever discharge of static electricity is a hazard.
-  **NOTE:** Do not exceed 6.9 bar (100 psig) air supply pressure for P1500 polypropylene pumps.
-  **CAUTION:** Do not exceed 8.6 bar (125 psig) air supply pressure for P1500 PVDF pumps.
-  **CAUTION:** Before any maintenance or repair is attempted, the compressed air line to the pump should be disconnected and all air pressure allowed to bleed from pump. Disconnect all intake, discharge and air lines. Drain the pump by turning it upside down and allowing any fluid to flow into a suitable container.
-  **CAUTION:** Blow out air line for 10 to 20 seconds before attaching to pump to make sure all pipe line debris is clear. Use an in-line air filter. A 5 $\mu$  (micron) air filter is recommended.
-  **NOTE:** When installing PTFE diaphragms, it is important to tighten outer pistons simultaneously (turning in opposite directions) to ensure tight fit.
-  **WARNING:** Tighten all bolts and retainers prior to installation. Fittings may loosen during transportation.
-  **NOTE:** Before starting disassembly, mark a line from each liquid chamber to its corresponding air chamber. This line will assist in proper alignment during reassembly.
-  **CAUTION:** Verify the chemical compatibility of the process and cleaning fluid to the pump's component materials in the Chemical Resistance Guide (see E4).
-  **CAUTION:** When removing the end cap using compressed air, the air valve end cap may come out with considerable force. Hand protection such as a padded glove or rag should be used to capture the end cap.
-  **CAUTION:** Pump is not rated for U.L. 79 service. For U.L. 79 transfer use Wilden's U.L.-approved T Series pump.
-  **NOTE:** The elbows and tees have bosses that are designed to be tapped with a 9.5 mm NPT (3/8") fitting for draining the pump during maintenance.
-  **CAUTION:** The P1500 Advanced™ Plastic is not submersible.

## SECTION 2

# WILDEN PUMP DESIGNATION SYSTEM

---

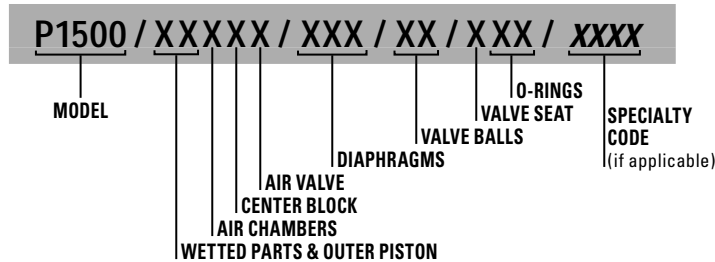

## MODEL P1500 PLASTIC MATERIAL CODES

---

### WETTED PARTS & OUTER PISTON

KK = PVDF / PVDF  
PK = POLYPROPYLENE / PVDF

### AIR CHAMBERS

P = POLYPROPYLENE

### CENTER BLOCK

P = POLYPROPYLENE

### AIR VALVE

P = POLYPROPYLENE

### DIAPHRAGMS

TEU = PTFE W/EPDM  
BACK-UP (White)  
TNU = PTFE W/NEOPRENE  
BACK-UP (White)

### VALVE BALL

TF = PTFE (White)

### VALVE SEAT

K = PVDF

### VALVE SEAT O-RING

TV = PTFE ENCAP. VITON®

## SPECIALTY CODES

---

0100 Wil-Gard II™ 110V  
0102 Wil-Gard II™ sensor wires ONLY  
0504 DIN flange  
0560 Split manifold  
0563 Split manifold, discharge ONLY  
0564 Split manifold, inlet ONLY  
0604 DIN flange, Wil-Gard II™ 220V  
0660 Split manifold, Wil-Gard II™ 110V

**NOTE:** MOST ELASTOMERIC MATERIALS USE COLORED DOTS FOR IDENTIFICATION.

## SECTION 3

# THE WILDEN PUMP — HOW IT WORKS

The Wilden diaphragm pump is an air-operated, positive displacement, self-priming pump. These drawings show the flow pattern through the pump upon its initial stroke. It is assumed the pump has no fluid in it prior to its initial stroke.

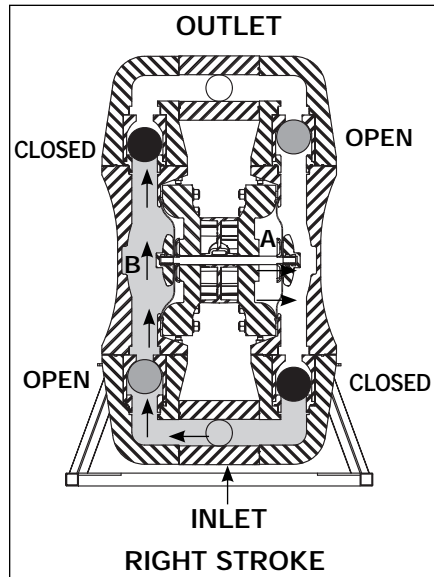

FIGURE 1 The air valve directs pressurized air to the back side of diaphragm A. The compressed air is applied directly to the liquid column separated by elastomeric diaphragms. The diaphragm acts as a separation membrane between the compressed air and liquid, balancing the load and removing mechanical stress from the diaphragm. The compressed air moves the diaphragm away from the center block of the pump. The opposite diaphragm is pulled in by the shaft connected to the pressurized diaphragm. Diaphragm B is on its suction stroke; air behind the diaphragm has been forced out to the atmosphere through the exhaust port of the pump. The movement of diaphragm B toward the center block of the pump creates a vacuum within chamber B. Atmospheric pressure forces fluid into the inlet manifold forcing the inlet valve ball off its seat. Liquid is free to move past the inlet valve ball and fill the liquid chamber (see shaded area).

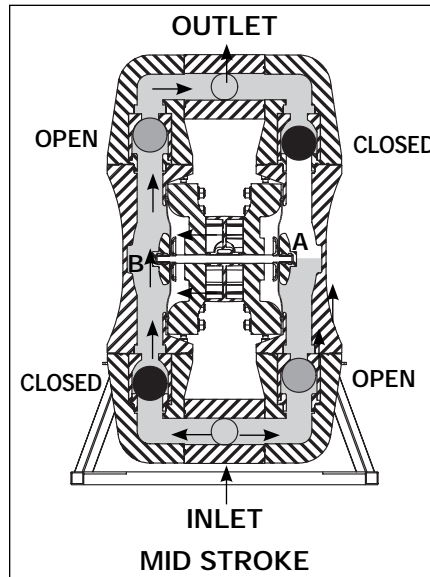

FIGURE 2 When the pressurized diaphragm, diaphragm A, reaches the limit of its discharge stroke, the air valve redirects pressurized air to the back side of diaphragm B. The pressurized air forces diaphragm B away from the center block while pulling diaphragm A to the center block. Diaphragm B is now on its discharge stroke. Diaphragm B forces the inlet valve ball onto its seat due to the hydraulic forces developed in the liquid chamber and manifold of the pump. These same hydraulic forces lift the discharge valve ball off its seat, while the opposite discharge valve ball is forced onto its seat, forcing fluid to flow through the pump discharge. The movement of diaphragm A toward the center block of the pump creates a vacuum within liquid chamber A. Atmospheric pressure forces fluid into the inlet manifold of the pump. The inlet valve ball is forced off its seat allowing the fluid being pumped to fill the liquid chamber.

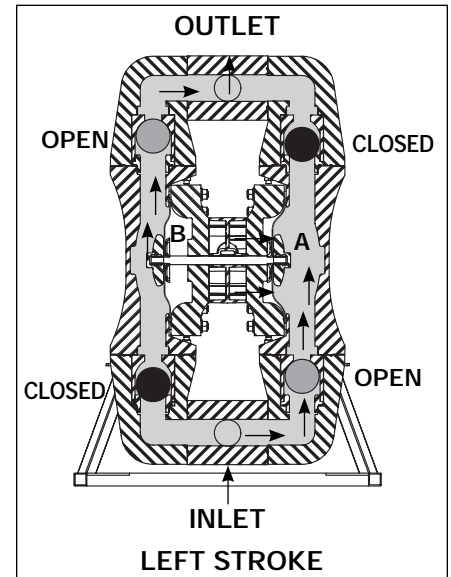
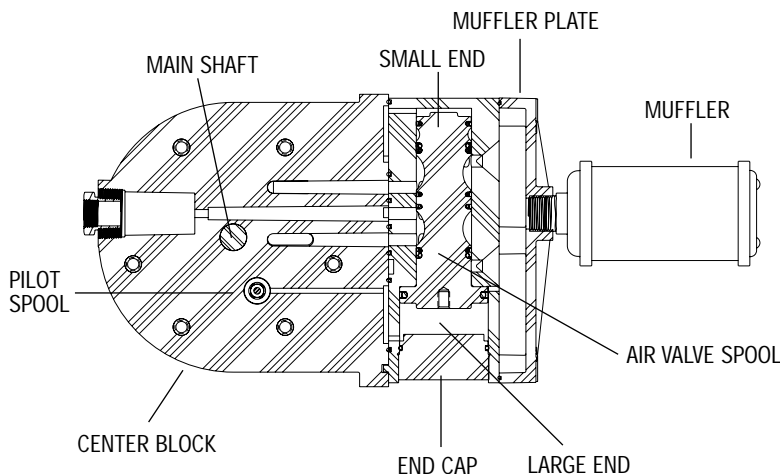

FIGURE 3 At completion of the stroke, the air valve again redirects air to the back side of diaphragm A, which starts diaphragm B on its suction stroke. As the pump reaches its original starting point, each diaphragm has gone through one suction and one discharge stroke. This constitutes one complete pumping cycle. The pump may take several cycles to completely prime depending on the conditions of the application.

## PRO-FLO® AIR DISTRIBUTION SYSTEM OPERATION — HOW IT WORKS

Figure A



The Pro-Flo® patented air distribution system incorporates three moving parts: the air valve spool, the pilot spool, and the main shaft/diaphragm assembly. The heart of the system is the air valve spool and air valve. As shown in Figure A, this valve design incorporates an unbalanced spool. The smaller end of the spool is pressurized continuously, while the large end is alternately pressurized and exhausted to move the spool. The spool directs pressurized air to one air chamber while exhausting the other. The air causes the main shaft/diaphragm assembly to shift to one side — discharging liquid on that side and pulling liquid in on the other side. When the shaft reaches the end of its stroke, the inner piston actuates the pilot spool, which pressurizes and exhausts the large end of the air valve spool. The repositioning of the air valve spool routes the air to the other air chamber.

# SECTION 4A

## DIMENSIONAL DRAWING P1500 ADVANCED™ PLASTIC PUMP

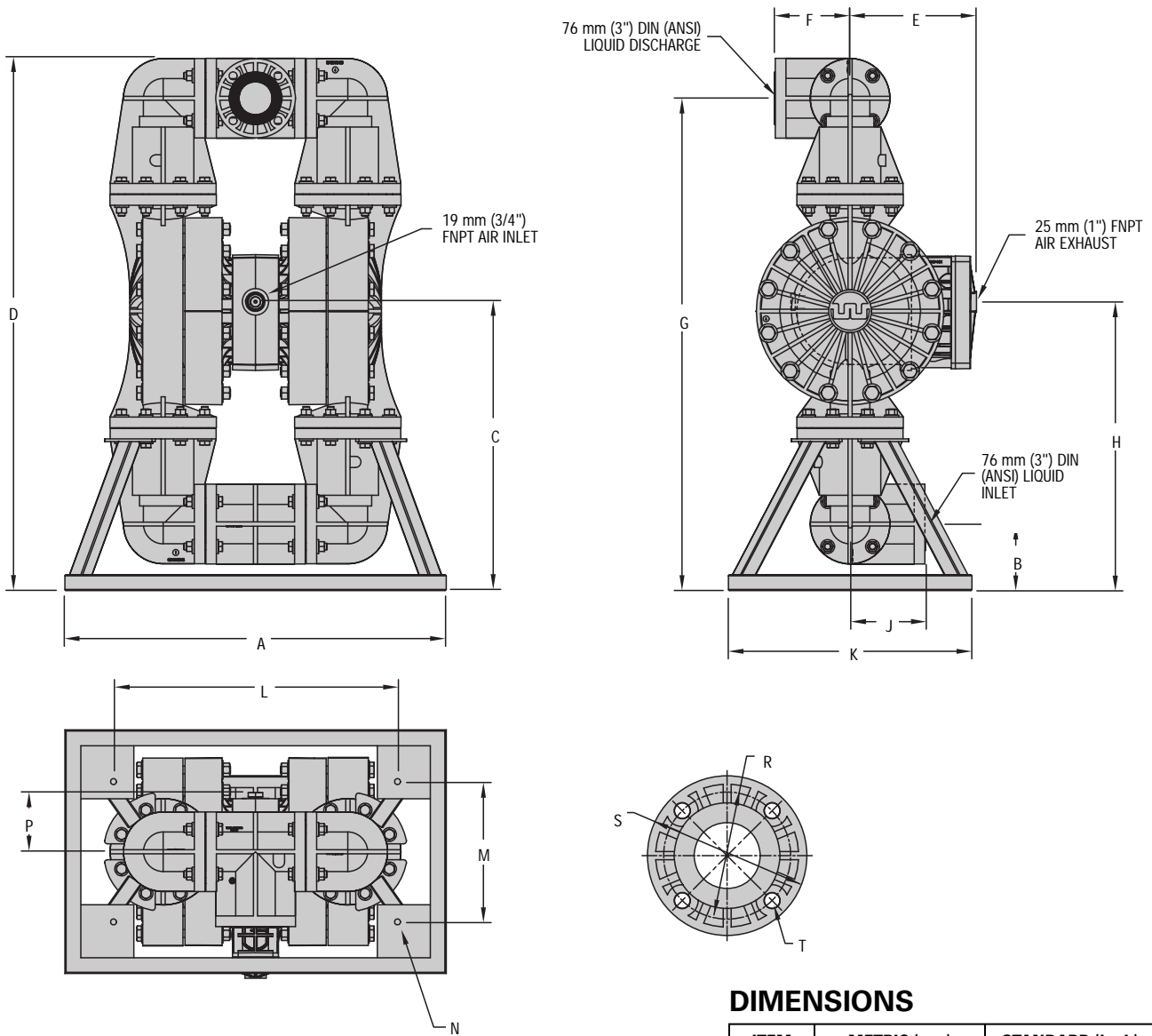

### DIMENSIONS

ITEM	METRIC (mm)	STANDARD (inch)
A	914	36.0
B	160	6.3
C	691	27.2
D	1279	50.4
E	303	11.9
F	181	7.1
G	12	46.5
H	693	27.3
J	181	7.1
K	584	23.0
L	681	26.8
M	336	13.2
N	14 DIA.	0.6 DIA.
P	149	5.9
<b>ANSI FLANGE</b>		
R	152 DIA.	6.0 DIA.
S	191 DIA.	7.5 DIA.
T	19 DIA.	0.8 DIA.



## SECTION 7A

# INSTALLATION – P1500 ADVANCED™ PLASTIC AIR-OPERATED PUMPS

The P1500 Advanced™ Plastic pump has a 76 mm (3") inlet and 76 mm (3") outlet and is designed for flows to 784 lpm (207 gpm). The Pro-Flo® P1500 Advanced™ Plastic pump is manufactured with wetted parts of polypropylene and PVDF. The center block of the P1500 Plastic pump is constructed of polypropylene. PTFE diaphragms, valve balls, and o-rings are employed to satisfy chemical compatibility concerns.

The suction pipe size should be at least 76 mm (3") diameter or larger if highly viscous material is being pumped. The suction hose must be non-collapsible, reinforced type as the P1500 is capable of pulling a high vacuum. Discharge piping should be at least 76 mm (3"); larger diameter can be used to reduce friction losses. It is critical that all fittings and connections are airtight or a reduction or loss of pump suction capability will result.

For P1500 Advanced™ Plastic models, Wilden offers 150 lb. standard flanges (ANSI or DIN). The following details should be noted when mating these to pipe works:

- A 60–80 shore gasket that covers the entire flange face should be used.
- The gasket should be between .075" and .175" thickness.

A non-raised surfaced-flange adapter should be utilized when mating to the pump's inlet and discharge manifolds for proper sealing.

**INSTALLATION:** Months of careful planning, study, and selection efforts can result in unsatisfactory pump performance if installation details are left to chance.

Premature failure and long term dissatisfaction can be avoided if reasonable care is exercised throughout the installation process.

**LOCATION:** Noise, safety, and other logistical factors usually dictate that "utility" equipment be situated away from the production floor. Multiple installations with conflicting requirements can result in congestion of utility areas, leaving few choices for siting of additional pumps.

Within the framework of these and other existing conditions, every pump should be located in such a way that five key factors are balanced against each other to maximum advantage.

**ACCESS:** First of all, the location should be accessible. If it's easy to reach the pump, maintenance personnel will have an easier time carrying out routine inspections and adjustments. Should major repairs become necessary, ease of access can play a key role in speeding the repair process and reducing total downtime.

**AIR SUPPLY:** Every pump location should have an air line large enough to supply the volume of air necessary to achieve the desired pumping rate (see Section 5).

For best results, the pumps should use a 5µ (micron) air filter, needle valve and regulator. The use of an air filter before the pump will insure that the majority of any pipeline contaminants will be eliminated.

**SOLENOID OPERATION:** When operation is controlled by a solenoid valve in the air line, three-way valves should be used, thus allowing trapped air to bleed off and improving pump performance. Pumping volume can be set by counting the number of strokes per minute and multiplying by displacement per stroke.

**MUFFLER:** Sound levels are reduced below OSHA specifications using the standard Wilden muffler. Other mufflers can be used to further reduce sound levels, but they may reduce pump performance.

**ELEVATION:** Selecting a site that is well within the pump's dynamic lift capability will assure that loss-of-prime troubles will be eliminated. In addition, pump efficiency can be adversely affected if proper attention is not given to elevation (see Section 5).

**PIPING:** Final determination of the pump site should not be made until the piping problems of each possible location have been evaluated. The impact of current and future installations should be considered ahead of time to make sure that inadvertent restrictions are not created for any remaining sites.

The best choice possible will be a site involving the shortest and the straightest hook-up of suction and discharge piping. Unnecessary elbows, bends, and fittings should be avoided. Pipe sizes should be selected so as to keep friction losses within practical limits. All piping should be supported independently of the pump. In addition, the piping should be aligned so as to avoid placing stresses on the pump fittings.

Expansion joints can be installed to aid in absorbing the forces created by the natural reciprocating action of the pump. If the pump is to be bolted down to a solid foundation, a mounting pad placed between the pump and foundation will assist in minimizing pump vibration. Flexible connections between the pump and rigid piping will also assist in minimizing pump vibration. If quick-closing valves are installed at any point in the discharge system, or if pulsation within a system becomes a problem, a surge suppressor should be installed to protect the pump, piping and gauges from surges and water hammer.

When pumps are installed in applications involving flooded suction or suction head pressures, a gate valve should be installed in the suction line to permit closing of the line for pump service.

**NOTE:** The elbows and tees have bosses that are designed to be tapped with a 9.5 mm (3/8") fitting for draining the pump during maintenance.

If the pump is to be used in a self-priming application, be sure that all connections are airtight and that suction lift is within the pump's ability.

Pumps in service with a positive suction head are most efficient when inlet pressure is limited to 0.5–0.7 bar (7–10 psig). Premature diaphragm failure may occur if positive suction is 0.8 Bar (11 psig) and higher.

**THE MODEL P1500 WILL PASS 13 mm (1/2") SOLIDS. WHENEVER THE POSSIBILITY EXISTS THAT LARGER SOLID OBJECTS MAY BE SUCKED INTO THE PUMP, A STRAINER SHOULD BE USED ON THE SUCTION LINE.**

**CAUTION: DO NOT EXCEED 6.9 BAR (100 PSIG) AIR SUPPLY PRESSURE ON P1500 POLYPROPYLENE PUMPS.**

**CAUTION: DO NOT EXCEED 8.6 BAR (125 PSIG) AIR SUPPLY PRESSURE ON PVDF PUMPS.**

**PUMPS SHOULD BE THOROUGHLY FLUSHED WITH WATER BEFORE INSTALLING INTO PROCESS LINES.**

**BLOW OUT AIR LINE FOR 10 TO 20 SECONDS BEFORE ATTACHING TO PUMP TO MAKE SURE ALL PIPE LINE DEBRIS IS CLEAR. ALWAYS USE AN IN-LINE AIR FILTER.**

**PRO-FLO® PUMPS ARE NOT SUBMERSIBLE.**



# SUGGESTED INSTALLATION

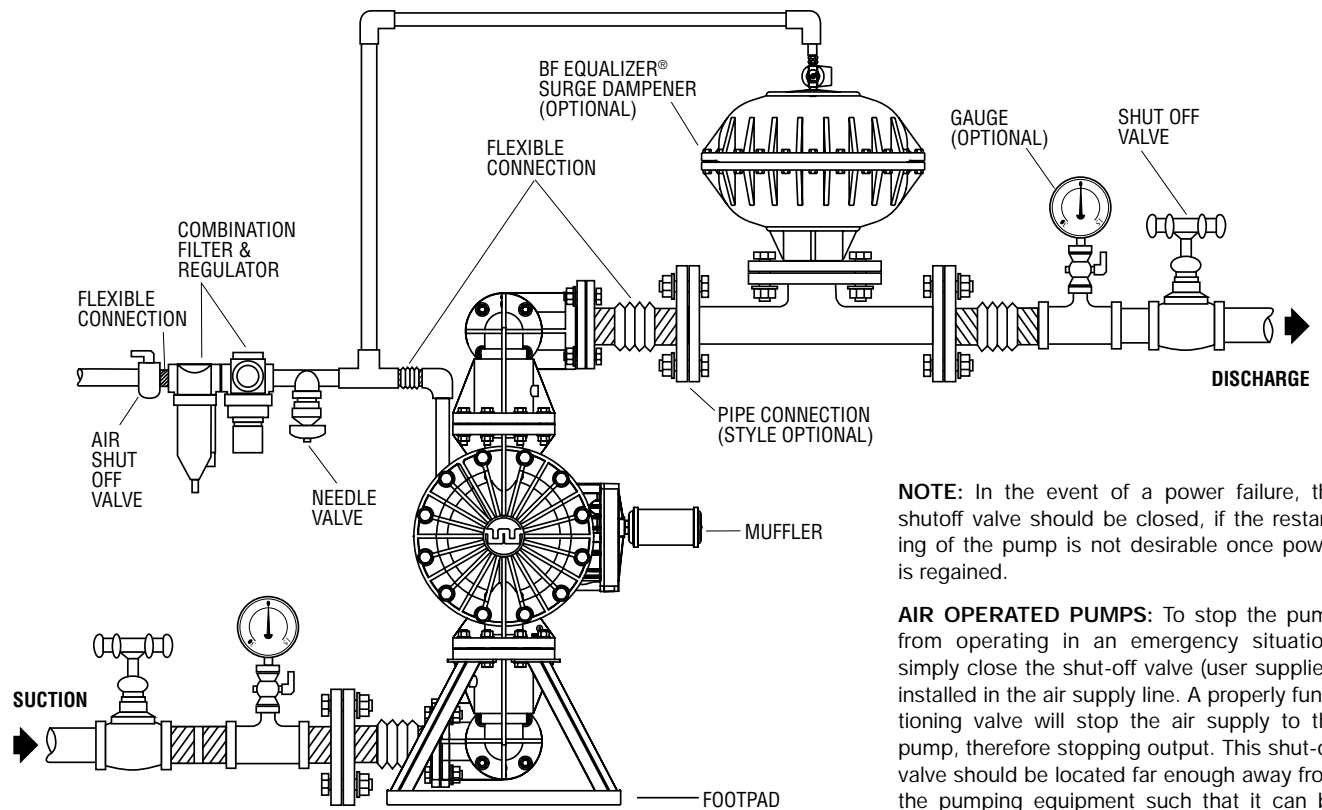

**NOTE:** In the event of a power failure, the shutoff valve should be closed, if the restarting of the pump is not desirable once power is regained.

**AIR OPERATED PUMPS:** To stop the pump from operating in an emergency situation, simply close the shut-off valve (user supplied) installed in the air supply line. A properly functioning valve will stop the air supply to the pump, therefore stopping output. This shut-off valve should be located far enough away from the pumping equipment such that it can be reached safely in an emergency situation.

## SECTION 7B – AIR OPERATION

# SUGGESTED OPERATION AND MAINTENANCE INSTRUCTIONS

**OPERATION:** The P1500 is pre-lubricated, and does not require in-line lubrication. Additional lubrication will not damage the pump, however if the pump is heavily lubricated by an external source, the internal lubrication may be flushed out. If the pump is then moved to a non-lubricated location, it may need to be disassembled and re-lubricated as described in the ASSEMBLY/DISASSEMBLY INSTRUCTIONS.

Pump discharge rate can be controlled by limiting the volume and/or pressure of the air supply to the pump (preferred method). An air regulator is used to regulate air pressure. A needle valve is used to regulate volume. Pump discharge rate can also be controlled by throttling the pump discharge by partially closing a valve in the discharge line of the pump. This action increases friction loss which reduces flow rate. This is useful when the need exists to control the pump from a remote location. When the pump discharge pressure equals or exceeds the air supply pressure, the pump will stop; no bypass or pressure relief valve is needed, and pump damage will not occur. The pump has reached a “deadhead” situation and can be restarted by reducing the fluid discharge pressure or increasing the air inlet pressure. The Wilden P1500 pump runs solely on compressed air and does not generate heat, therefore your process fluid temperature will not be affected.

**MAINTENANCE AND INSPECTIONS:** Since each application is unique, maintenance schedules may be different for every pump. Frequency of use, line pressure, viscosity and abrasiveness of process fluid all affect the parts life of a Wilden pump. Periodic inspections have been found to offer the best means for preventing unscheduled pump downtime. Personnel familiar with the pump’s construction and service should be informed of any abnormalities that are detected during operation.

**RECORDS:** When service is required, a record should be made of all necessary repairs and replacements. Over a period of time, such records can become a valuable tool for predicting and preventing future maintenance problems and unscheduled downtime. In addition, accurate records make it possible to identify pumps that are poorly suited to their applications.

# SECTION 7C – AIR OPERATION

## TROUBLESHOOTING

---

### ***Pump will not run or runs slowly.***

1. Ensure that the air inlet pressure is at least 0.4 bar (5 psig) above startup pressure and that the differential pressure (the difference between air inlet and liquid discharge pressures) is not less than 0.7 bar (10 psig).
2. Check air inlet filter for debris (see recommended installation).
3. Check for extreme air leakage (blow by) which would indicate worn seals/bores in the air valve, pilot spool, main shaft.
4. Disassemble pump and check for obstructions in the air passageways or objects which would obstruct the movement of internal parts.
5. Check for sticking ball check valves. If material being pumped is not compatible with pump elastomers, swelling may occur. Replace ball check valves and seals with proper elastomers. Also, as the check valve balls wear out, they become smaller and can become stuck in the seats. In this case, replace balls and seats.
6. Check for broken inner piston which will cause the air valve spool to be unable to shift.
7. Remove plug from pilot spool exhaust.

### ***Pump runs but little or no product flows.***

1. Check for pump cavitation; slow pump speed down to allow thick material to flow into liquid chambers.
2. Verify that vacuum required to lift liquid is not greater than the vapor pressure of the material being pumped (cavitation).

3. Check for sticking ball check valves. If material being pumped is not compatible with pump elastomers, swelling may occur. Replace ball check valves and seals with proper elastomers. Also, as the check valve balls wear out, they become smaller and can become stuck in the seats. In this case, replace balls and seats.

### ***Pump air valve freezes.***

1. Check for excessive moisture in compressed air. Either install a dryer or hot air generator for compressed air. Alternatively, a coalescing filter may be used to remove the water from the compressed air in some applications.

### ***Air bubbles in pump discharge.***

1. Check for ruptured diaphragm.
2. Check tightness of outer pistons (refer to Section 8C).
3. Check tightness of wetted path fasteners and integrity of o-rings and seals, especially at intake manifold.
4. Ensure pipe connections are airtight.

### ***Product comes out air exhaust.***

1. Check for diaphragm rupture.
2. Check tightness of outer pistons to shaft.

## SECTION 8A

# P1500 ADVANCED™ PLASTIC DIRECTIONS FOR DISASSEMBLY/REASSEMBLY

**CAUTION:** Before any maintenance or repair is attempted, the compressed air line to the pump should be disconnected and all air pressure allowed to bleed from the pump. Disconnect all intake, discharge, and air lines. Drain the pump by turning it upside down and allowing any fluid to flow into a suitable container. Be aware of any hazardous effects of contact with your process fluid.

The Wilden P1500 has a 76 mm (3") inlet and outlet and is designed for flows up to 784 lpm (207 gpm). Its air distribution system is based on a revolutionary design which increases reliability and performance. The model P1500 is available in injection molded polypropylene and PVDF.

### TOOLS REQUIRED:

(2 qty.) 5/8" Box Wrench  
(2 qty.) 3/4" Box Wrench  
1-1/8" Box Wrench  
Adjustable Wrench  
Vise equipped with soft jaws (such as plywood, plastic or other suitable material)

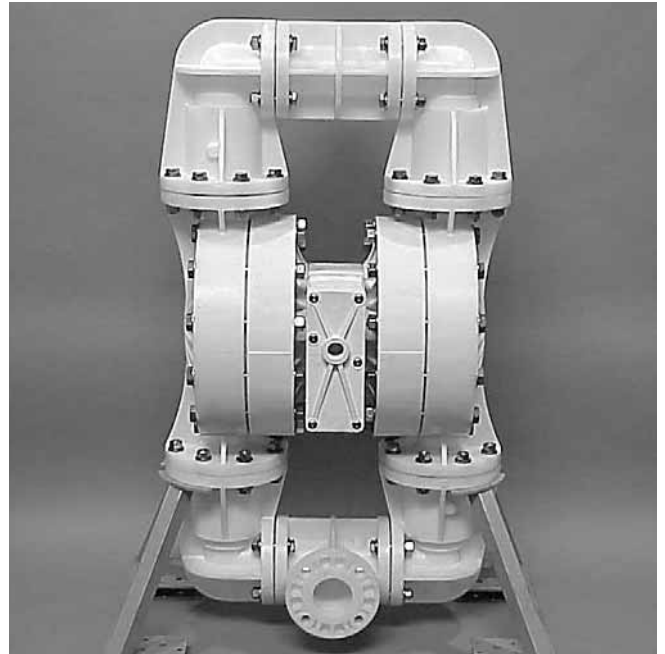

### DISASSEMBLY:

Figure 1

#### Step 1.

Take the proper safety precautions to work on the pump.

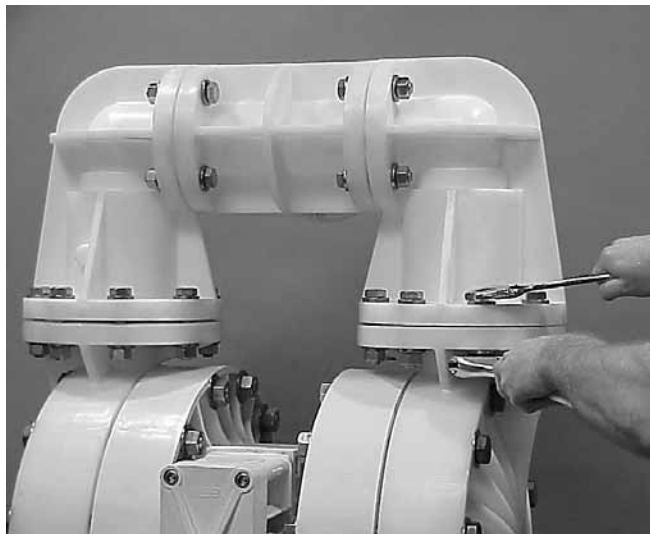

#### Step 2.

Figure 2

Utilizing the two 5/8" adjustable wrenches, remove bolts that fasten the discharge manifold to the liquid chambers.

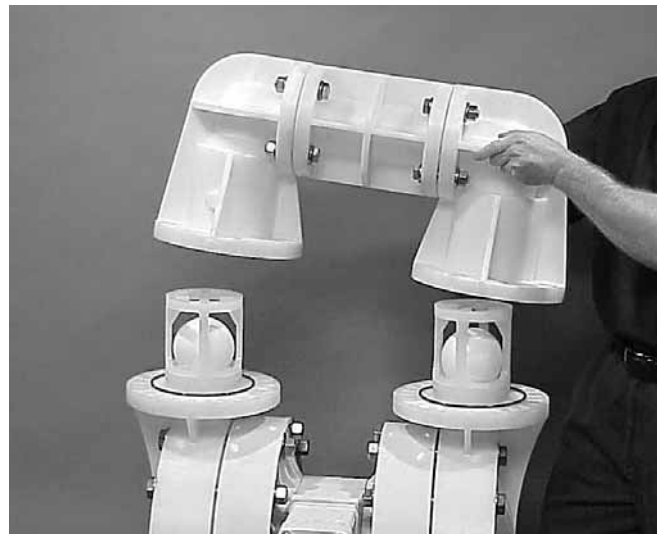

#### Step 3.

Figure 3

Remove the discharge manifold to expose the valve balls, valve seats, and o-rings. Inspect the o-rings for nicks, gouges, or chemical attack. Replace with genuine Wilden parts if needed. Inspect the ball cage area of manifold for excessive wear or damage.



**Step 4.** *Figure 4*  
 Rotate the ball cage counterclockwise to remove the threaded ball seat. The ball cage has feet that interlock with the seat to facilitate this operation.

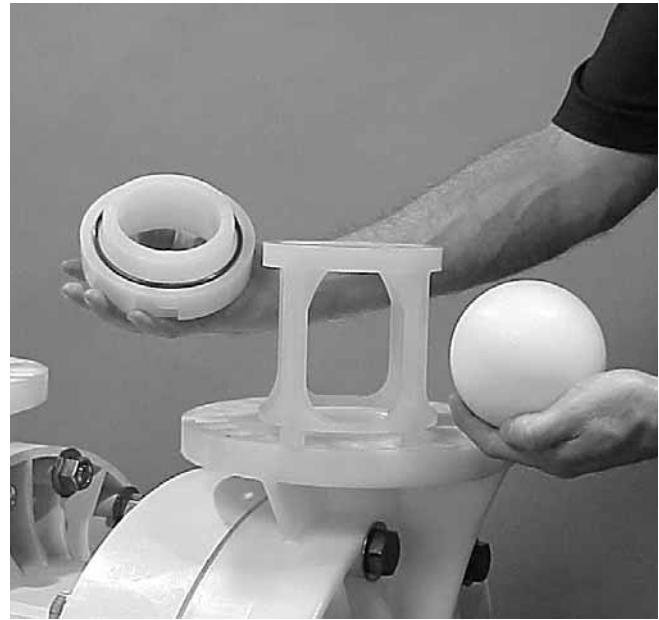

**Step 5.** *Figure 5*  
 After removing the discharge valve seat, remove the valve seat o-ring and inspect valve seat, valve seat o-ring, valve balls and ball cage for nicks, gouges, chemical attack or abrasive wear. Replace worn parts with genuine Wilden parts for reliable performance.

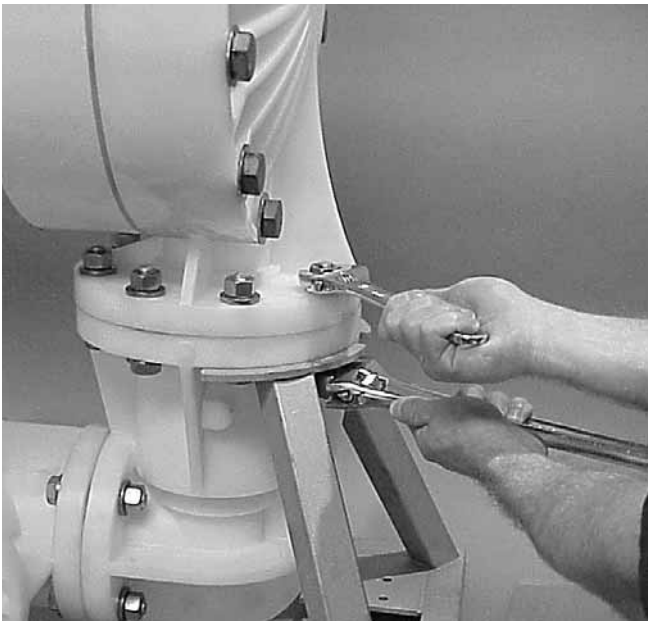

**Step 6.** *Figure 6*  
 Remove the bolts that secure the liquid chambers and center section to the intake manifold.

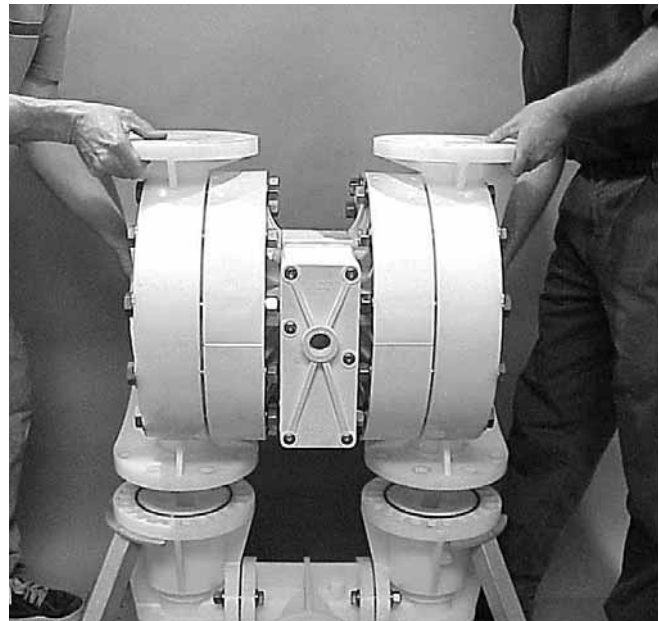

**Step 7.** *Figure 7*  
 Lift intake manifold from liquid chambers and center section to expose intake valve balls and seats. Inspect the ball cage area of manifold for excessive wear or damage. Repeat Steps 4-6.

**NOTE:** Two people or a jib crane is recommended to perform Step 8.

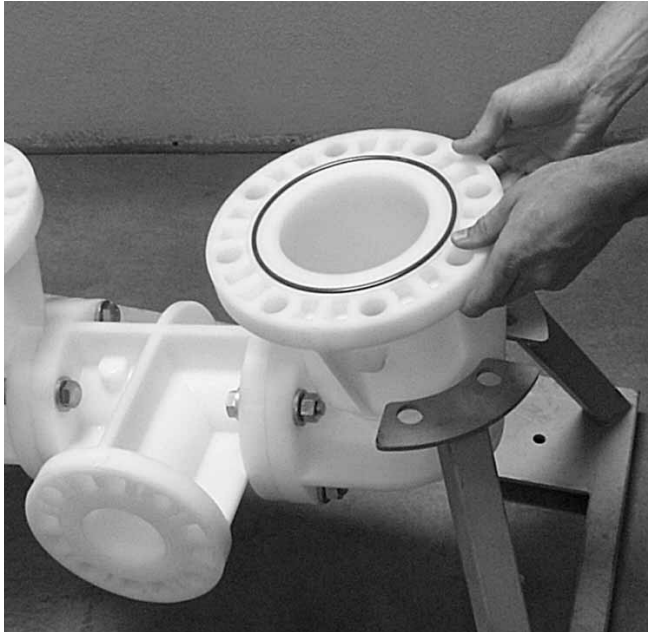

**Step 8.** *Figure 8*

Lift one side of the intake manifold, then slide out the other side to remove the manifold from the mounting stand. Normally inlet and discharge manifolds should not be disassembled during regular pump maintenance. Should this be necessary, completely remove the bolts and inspect o-rings for nicks, cuts and chemical attack.

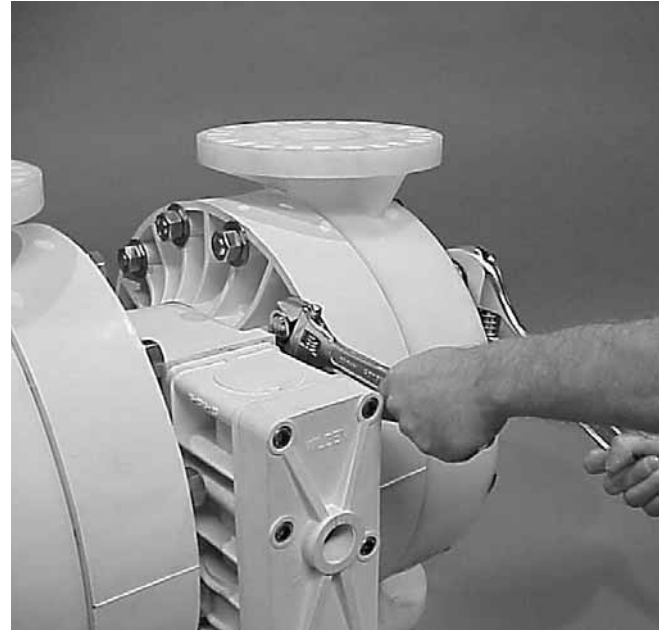

**Step 9.** *Figure 9*

With the adjustable wrenches, remove the bolts that secure the liquid chamber to the air chamber (Figure 9). Using an adjustable wrench, or by rotating the diaphragm by hand, remove the diaphragm assembly. (Figure 10a)

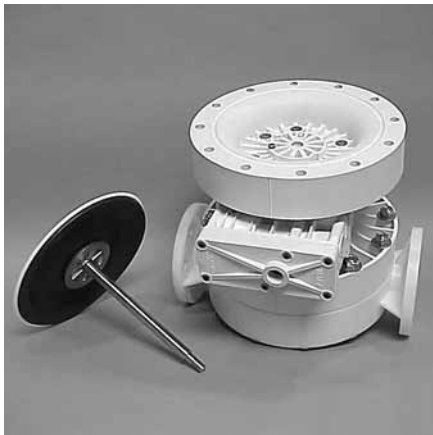

**Step 10.** *Figure 10a*

*Figure 10b*

**NOTE:** Due to varying torque values, one of the following two situations may occur: 1) The outer piston, diaphragm and inner piston remain attached to the shaft and the entire assembly can be removed from the center section (Figure 10a); 2) The outer piston, diaphragm and inner piston separate from the shaft which remains connected to the opposite side diaphragm assembly (Figure 10b). Repeat disassembly instructions for the opposite liquid chamber. Inspect diaphragm assembly and shaft for signs of wear or chemical attack. Replace all worn parts with genuine Wilden parts for reliable performance. Rubber/TPE are not available.



**Step 11.** *Figure 11*

To remove diaphragm assembly from shaft, secure shaft with soft jaws (a vise fitted with plywood or other suitable material) to ensure shaft is not nicked, scratched or gouged. Using an adjustable wrench, remove diaphragm assembly from shaft.

## SECTION 8B

# PRO-FLO® AIR VALVE/CENTER SECTION DISASSEMBLY, CLEANING, INSPECTION

### AIR VALVE DISASSEMBLY:

**CAUTION:** Before any maintenance or repair is attempted, the compressed air line to the pump should be disconnected and all air pressure allowed to bleed from the pump. Disconnect all intake, discharge, and air lines. Drain the pump into a suitable container. Be aware of hazardous effects of contact with your process fluid.

The Wilden P1500 Advanced™ Plastic utilizes a revolutionary Pro-Flo® air distribution system. A 19 mm (3/4") air inlet connects the air supply to the center section. Proprietary composite seals reduce the coefficient of friction and allow the P1500 to run lube-free. Constructed of polypropylene, the Pro-Flo® air distribution system is designed to perform in on/off, non-freezing, non-stalling, tough duty applications.

### TOOLS REQUIRED:

3/8" Hex Head Wrench  
3/4" Hex Socket  
Snap Ring Pliers  
O-Ring Pick

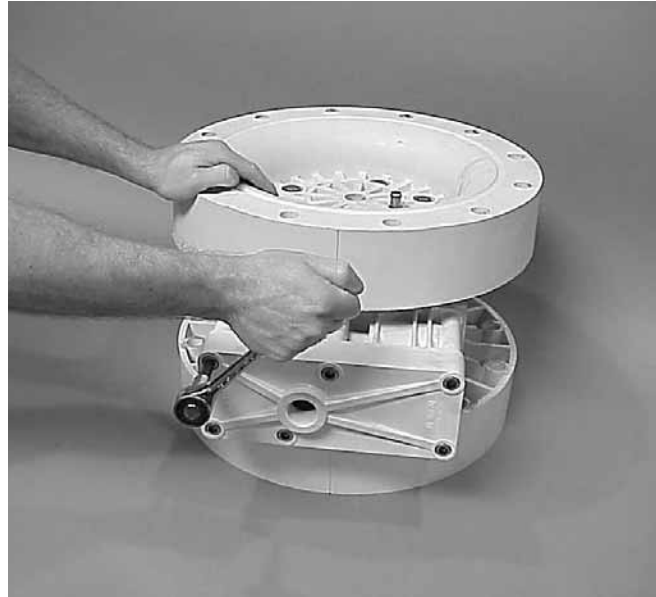

**Step 1.** *Figure 1*  
Loosen the air valve bolts utilizing a 3/8" hex head wrench.

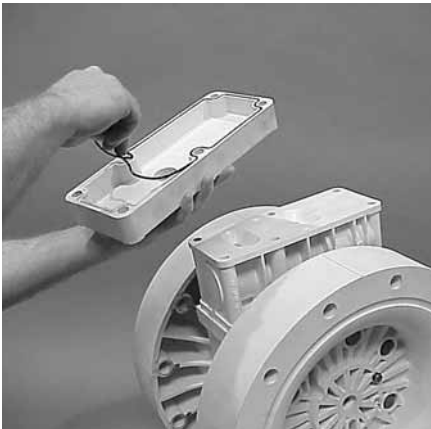

**Step 2.** *Figure 2*  
Remove muffer plate and air valve bolts from air valve assembly exposing muffer gasket for inspection. Replace if necessary.

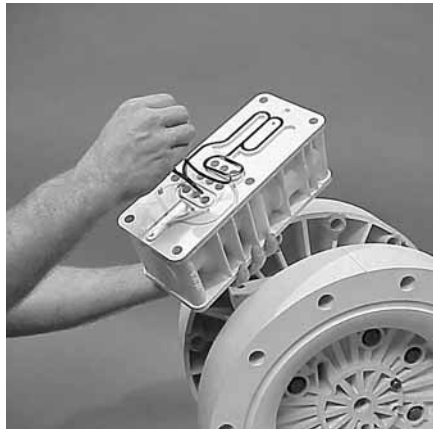

**Step 3.** *Figure 3*  
Lift away air valve assembly and remove air valve gasket for inspection. Replace if necessary.

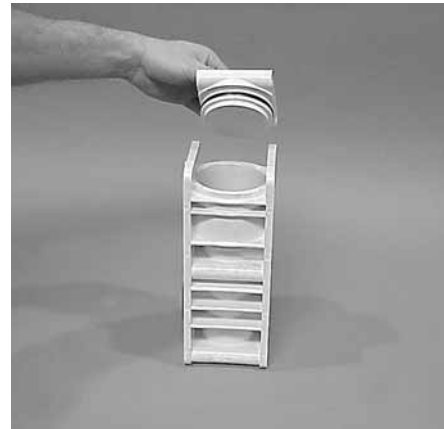

**Step 4.** *Figure 4*  
Remove air valve end cap to expose air valve spool by simply lifting up on end cap once air valve bolts are removed.

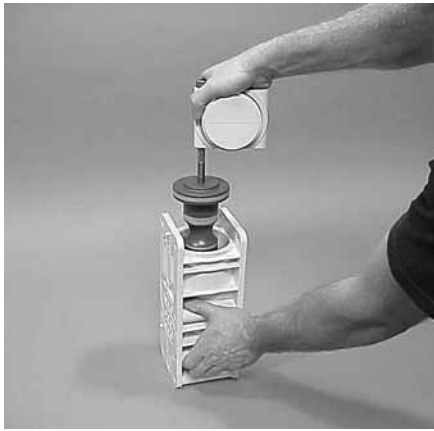

**Step 5.** *Figure 5*

Remove air valve spool from air valve body by threading one air valve bolt into the end of the spool and gently sliding the spool out of the air valve body. Inspect seals for signs of wear and replace entire assembly if necessary. Use caution when handling air valve spool to prevent damaging seals.

**NOTE:** Seals should not be removed from assembly. Seals are not sold separately.

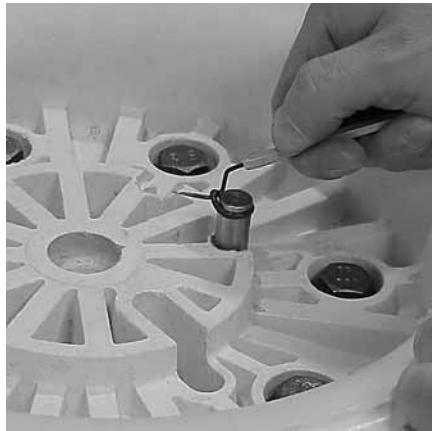

**Step 6.** *Figure 6*

Remove pilot spool retaining o-rings on both sides of center section with o-ring pick.

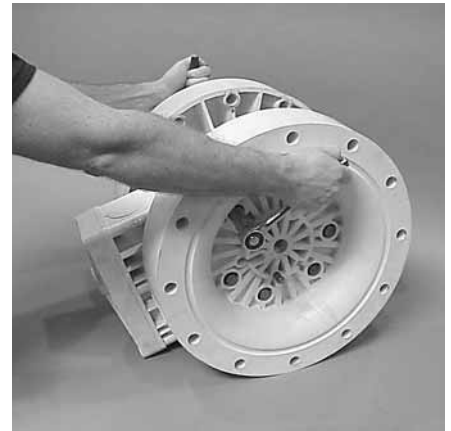

**Step 7.** *Figure 7*

Remove air chamber bolts with 3/4" hex socket.

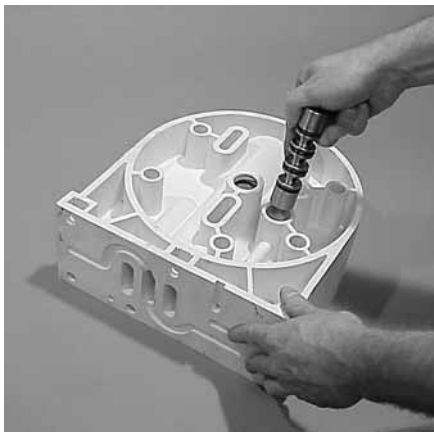

**Step 8.** *Figure 8*

Remove pilot spool bushing from center block.



**Step 9.** *Figure 9*

Gently remove pilot spool from bushing and inspect spool and seals for nicks, gouges or other signs of wear. Replace pilot sleeve assembly or outer bushing o-rings if necessary.

**NOTE:** Seals should not be removed from pilot spool. Seals are not sold separately. The end of the pilot spool that has a "center hole" in it should not be fed into the bore first (see TB 1296)



**Step 10.** *Figure 10*

Check center block Glyd™ Rings for signs of wear. If necessary, remove Glyd™ Rings with o-ring pick and replace.

## SECTION 8C

# REASSEMBLY HINTS & TIPS

### ASSEMBLY:

Upon performing applicable maintenance to the air distribution system, the pump can now be reassembled. Please refer to the disassembly instructions for photos and parts placement. To reassemble the pump, follow the disassembly instructions in reverse order. The air distribution system needs to be assembled first, then the diaphragms and finally the wetted path. Please find the applicable torque specifications on this page. The following tips will assist in the assembly process.

- Lubricate air valve bore, center section shaft and pilot spool bore with NLGI grade 2 white EP grease or equivalent.
- Clean the inside of the center section shaft bushing to ensure no damage is done to new glyd ring seals.
- A small amount NLGI grade 2 white EP grease can be applied to the muffler and air valve gaskets to locate gaskets during assembly.
- Make sure that the exhaust port on the muffler plate is centered between the two exhaust ports on the center section.
- Stainless bolts should be lubed to reduce the possibility of seizing during tightening.

### MAXIMUM TORQUE SPECIFICATIONS

Description of Part	Plastic Pumps
Air Valve	8.5 N•m (75 in-lbs)
Outer Piston	135.6 N•m (100 ft-lbs)
Air Chamber/Center Block	74.6 N•m (55 ft-lbs)
Tee Section/Elbow	43.4 N•m (32 ft-lbs)
Elbow/Liquid Chamber	43.4 N•m (32 ft-lbs)
Liquid Chamber/Air Chamber	43.4 N•m (32 ft-lbs)

### GLYD™ RING INSTALLATION:

#### PRE-INSTALLATION

- Once all of the old seals have been removed, the inside of the bushing should be cleaned to ensure no debris is left that may cause premature damage to the new seals.

#### INSTALLATION

The following tools can be used to aid in the installation of the new seals:

Needle Nose Pliers  
Phillips Screwdriver  
Electrical Tape

- Wrap electrical tape around each leg of the needle nose pliers (heat shrink tubing may also be used). This is done to prevent damaging the inside surface of the new seal.
- With a new seal in hand, place the two legs of the needle nose pliers inside the seal ring. (See Figure A.)
- Open the pliers as wide as the seal diameter will allow, then with two fingers pull down on the top portion of the seal to form kidney bean shape. (See Figure B.)
- Lightly clamp the pliers together to hold the seal into the kidney shape. Be sure to pull the seal into as tight of a kidney shape as possible, this will allow the seal to travel down the bushing bore easier.
- With the seal clamped in the pliers, insert the seal into the bushing bore and position the bottom of the seal into the correct groove. Once the bottom of the seal is seated in the groove, release the clamp pressure on the pliers. This will allow the seal to partially snap back to its original shape.
- After the pliers are removed, you will notice a slight bump in the seal shape. Before the seal can be properly resized, the bump in the seal should be removed as much as possible. This can be done with either the Phillips screwdriver or your finger. With either the side of the screwdriver or your finger, apply light pressure to the peak of the bump. This pressure will cause the bump to be almost completely eliminated.
- Lubricate the edge of the shaft with NLGI grade 2 white EP grease.
- Slowly insert the center shaft with a rotating motion. This will complete the resizing of the seal.
- Perform these steps for the remaining seal.

Figure A

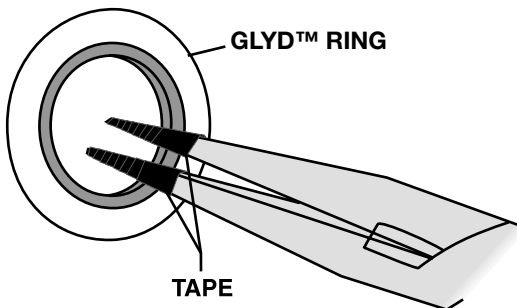
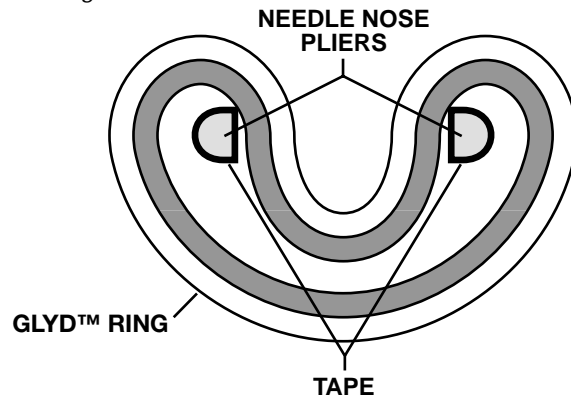

Figure B





# Elastomer Kits

## *Your Solutions — Wrapped Up*

### ***Program Details:***

- **Elastomer & ADS Repair Kits**
- **All Sizes Available**
- **PTFE, Rubber & TPE Elastomers**
- **One Part Number Simplifies Inventory**
- **Eliminates Order Errors**
- **Reduces Re-Build Time**
- **Rejuvenates Your Pump**

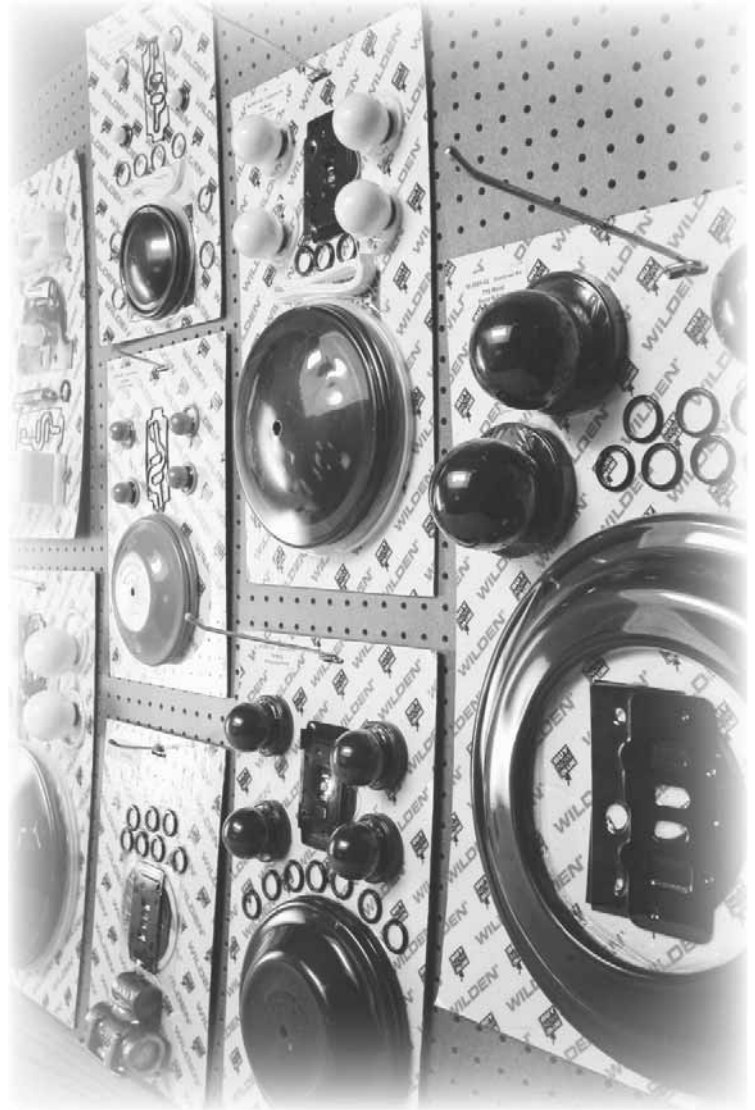

*NOTE: See Section 9.*

# **WILDEN®**

A **DOVER** COMPANY

22069 VAN BUREN STREET • GRAND TERRACE, CA 92313-5607  
(909) 422-1730 • FAX (909) 783-3440  
[www.wildenpump.com](http://www.wildenpump.com)

EXPLODED VIEW/PARTS LISTING

# P1500

ADVANCED™  
PLASTIC  
AIR DISTRIBUTION  
SYSTEM

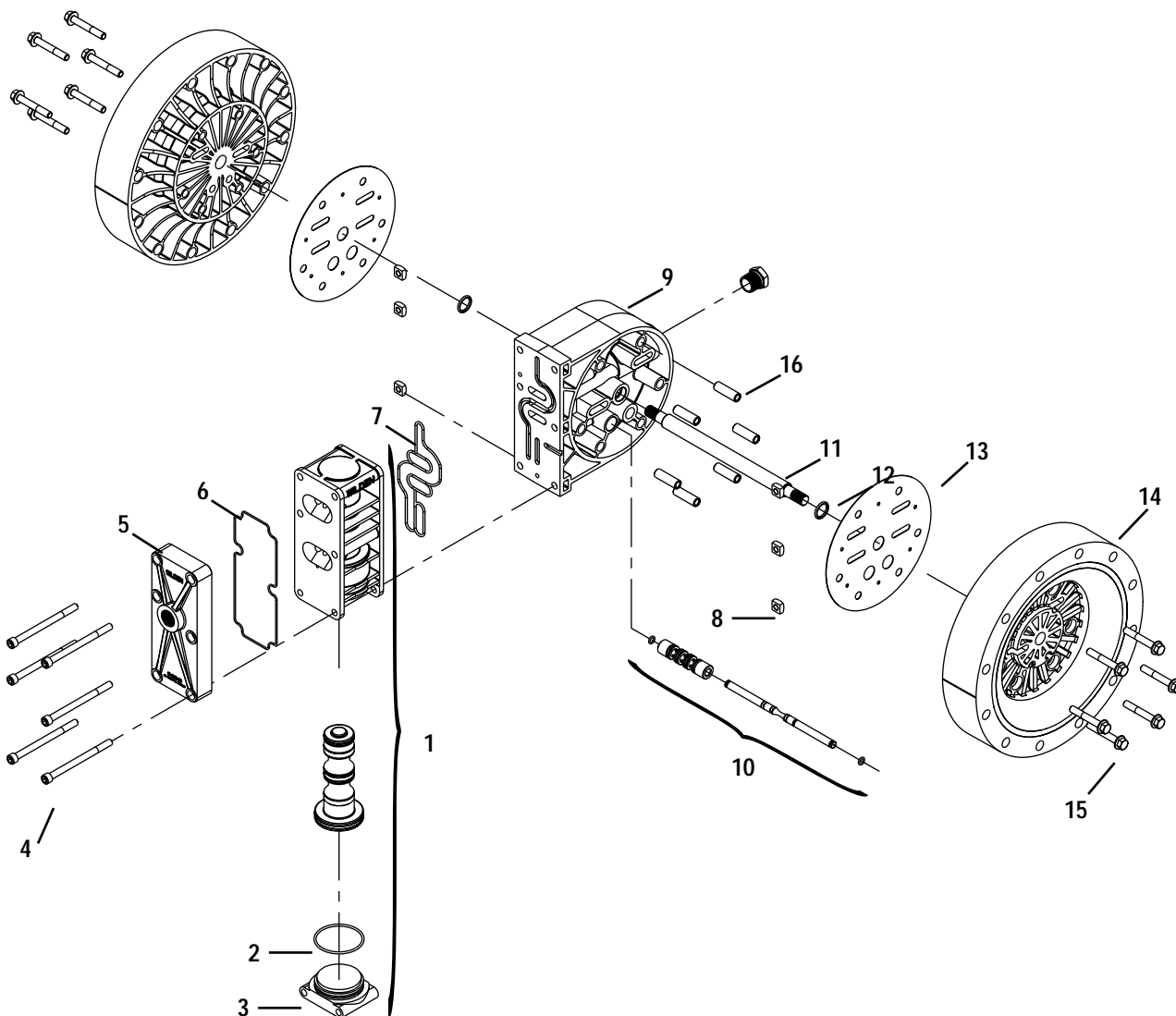

## P1500 ADVANCED™ PLASTIC AIR DISTRIBUTION SYSTEM

Item No.	Description	Qty.	P1500/PKPPP Part Number	P1500/KKPPP Part Number
<b>1</b>	<b>Pro-Flo® Air Valve Assembly<sup>1</sup></b>	<b>1</b>	<b>15-2010-20</b>	<b>15-2010-20</b>
2	O-Ring (-235), End Cap	1	71-1280-52	71-1280-52
3	End Cap, Pro-Flo®	1	15-2332-20	15-2332-20
4	Screw, SHCS, Air Valve (7/16-14 x 5-7/8")	6	15-6001-03	15-6001-03
5	Muffler Plate, Pro-Flo®	1	15-3181-20	15-3181-20
6	Gasket, Muffler Plate	1	15-3505-52	15-3505-52
7	Gasket, Air Valve	1	15-2615-52	15-2615-52
8	Nut, Square (7/16-14)	6	15-6506-03	15-6506-03
9	Center Block Assembly <sup>2</sup>	1	15-3110-20	15-3110-20
10	Removable Pilot Sleeve Assembly	1	15-3882-99	15-3882-99
11	Shaft	1	15-3842-03	15-3842-03
<b>12</b>	<b>Center Block Glyd™ Ring</b>	<b>2</b>	<b>15-3210-55-225</b>	<b>15-3210-55-225</b>
13	Gasket, Center Block, Pro-Flo®	2	15-3525-52	15-3525-52
14	Air Chamber, Pro-Flo®	2	15-3681-20	15-3681-20
15	Air Chamber Screw 1/2-13 x 3-1/4"	12	15-6201-03	15-6201-03
16	Threaded Sleeve	6	15-7710-08	15-7710-08

<sup>1</sup>Air Valve Assembly includes items 2 and 3.

<sup>2</sup>Center Block Assembly includes item 12.

**All boldface items are primary wear parts.**

EXPLODED VIEW/PARTS LISTING

# P1500

ADVANCED™  
PLASTIC  
LIQUID PATH

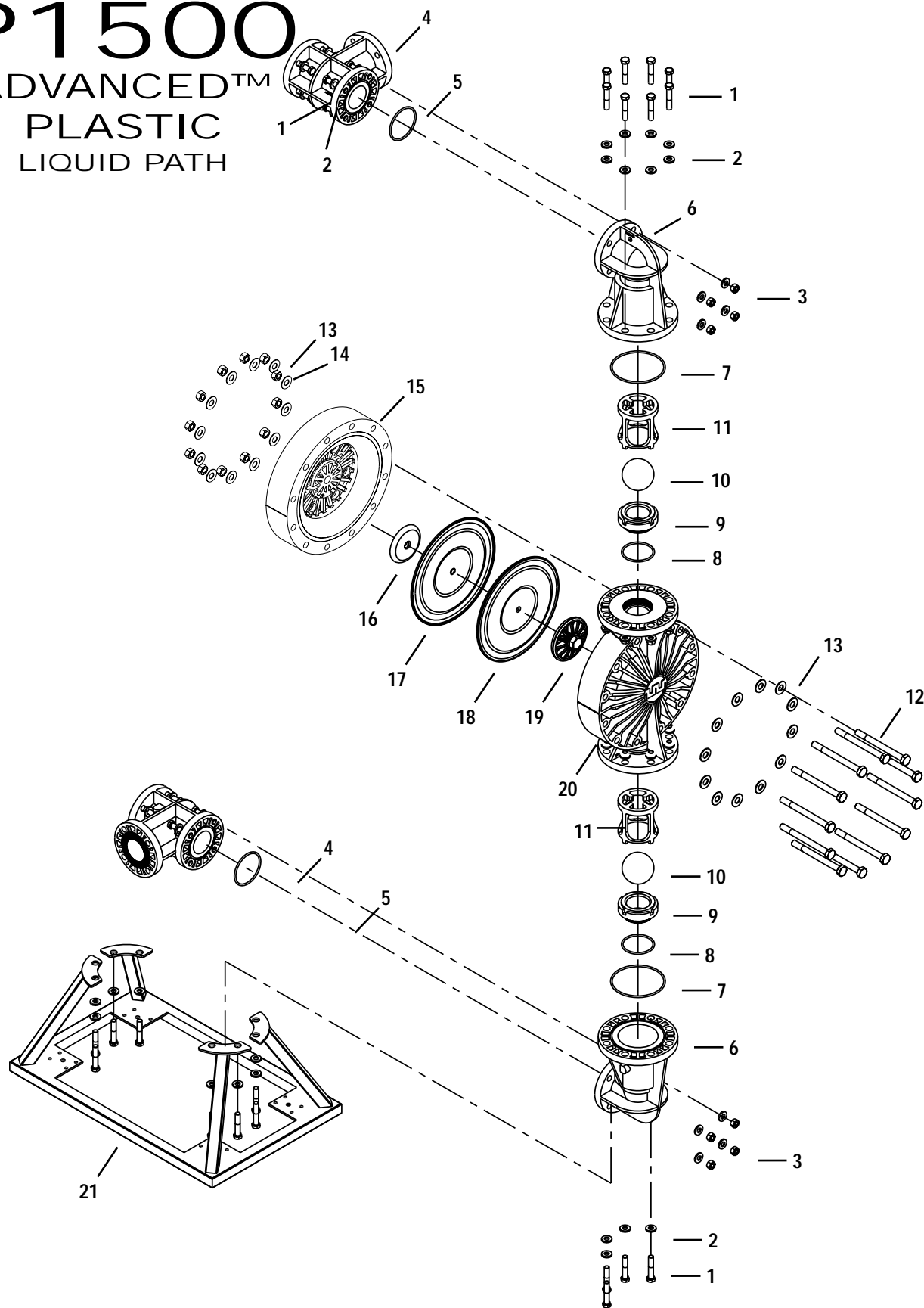

## P1500 ADVANCED™ PLASTIC LIQUID PATH

Item No.	Description	Qty.	P1500/PKPPP Part Number	P1500/KKPPP Part Number
1	Bolt, HHCS, 5/8-11 x 3 1/4	48	15-6181-03	15-6181-03
2	Washer, 5/8 (.660 x 1.312 x .187)	96	15-6730-03	15-6730-03
3	Nut, Hex, 5/8-11	48	15-6430-03	15-6430-03
4	Tee Section*	2	15-5180-20	15-5180-21
5	Tee Section O-Ring	4	15-1300-60	15-1300-60
6	Combo Elbow	4	15-5240-20	15-5240-21
7	Elbow O-Ring	4	15-1370-60	15-1370-60
<b>8</b>	<b>Valve Seat O-Ring</b>	<b>4</b>	<b>08-1200-60-500</b>	<b>08-1200-60-500</b>
<b>9</b>	<b>Valve Seat</b>	<b>4</b>	<b>15-1120-21</b>	<b>15-1120-21</b>
<b>10</b>	<b>Valve Ball</b>	<b>4</b>	<b>15-1085-55</b>	<b>15-1085-55</b>
<b>11</b>	<b>Ball Cage</b>	<b>4</b>	<b>15-5350-20</b>	<b>15-5350-21</b>
12	Screw, HH, 3/4-10 x 8 3/8"	24	15-6192-03	15-6192-03
13	Washer, 3/4 (.812 x 1.750 x .095)	48	15-6735-03	15-6735-03
14	Nut, Hex, 3/4-10	24	15-6425-03	15-6425-03
15	Air chamber, Pro-Flo®	2	15-3681-20	15-3681-20
16	Inner Piston	2	15-3750-03	15-3750-03
<b>17</b>	<b>Neoprene Backup Diaphragm</b>	<b>2</b>	<b>15-1060-51</b>	<b>15-1060-51</b>
<b>18</b>	<b>PTFE Primary Diaphragm</b>	<b>2</b>	<b>15-1010-55</b>	<b>15-1010-55</b>
19	Outer Piston	2	15-4600-21	15-4600-21
20	Liquid Chamber	2	15-5000-20	15-5000-21
21	Pump Stand	1	15-7650-03	15-7650-03

\*Tee Section, DIN Flange (15-5185-21 & 15-5185-20) Available Upon Request.

**All boldface items are primary wear parts.**

# Finding spares a nightmare?

Sleep easier with



## PRODUCTS:

### AODDP

(Air Operated Double Diaphragm Pumps)

- Warren-Rupp
- ARO
- Other

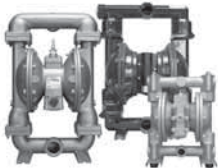

## PUMP PARTS

(Low Cost)

- Diaphragms
- Valve balls
- Valve seats



## KNOWLEDGE & SERVICE

- Competitive pricing
- Delivery
- Service
- Inventory



Spectrom is not your typical after market part supplier. We do not simply sell pump parts; we provide value added procurement solutions.

Our unique network enables us to purchase effectively, resulting in low cost solutions. We also know that low purchase price is not enough - quality, integrity and inventory are also important. Spectrom is structured to provide Pre and Post sales support, giving our customers value added application and pump knowledge.

Contact us to have a procurement solution developed for you. We don't just fit you into a generic system, we develop specific solutions that achieve results.

***Spectrom will ship your order from our facility within 3 working days!***

**WARNING**

These parts may exhibit better life than OEM parts.

1-909-512-1261



[www.spectromparts.com](http://www.spectromparts.com)

## WARRANTY

Each and every product manufactured by Wilden Pump and Engineering, LLC is built to meet the highest standards of quality. Every pump is functionally tested to insure integrity of operation.

Wilden Pump and Engineering, LLC warrants that pumps, accessories and parts manufactured or supplied by it to be free from defects in material and workmanship for a period of five (5) years from date of installation or six (6) years from date of manufacture, whichever comes first. Failure due to normal wear, misapplication, or abuse is, of course, excluded from this warranty.

Since the use of Wilden pumps and parts is beyond our control, we cannot guarantee the suitability of any pump or part for a particular application and Wilden Pump and Engineering, LLC shall not be liable for any consequential damage or expense arising from the use or misuse of its products on any application. Responsibility is limited solely to replacement or repair of defective Wilden pumps and parts.

All decisions as to the cause of failure are the sole determination of Wilden Pump and Engineering, LLC.

Prior approval must be obtained from Wilden for return of any items for warranty consideration and must be accompanied by the appropriate MSDS for the product(s) involved. A Return Goods Tag, obtained from an authorized Wilden distributor, must be included with the items which must be shipped freight prepaid.

The foregoing warranty is exclusive and in lieu of all other warranties expressed or implied (whether written or oral) including all implied warranties of merchantability and fitness for any particular purpose. No distributor or other person is authorized to assume any liability or obligation for Wilden Pump and Engineering, LLC other than expressly provided herein.

### PLEASE PRINT OR TYPE AND FAX TO WILDEN

PUMP INFORMATION			
Item # _____		Serial # _____	
Company Where Purchased _____			
YOUR INFORMATION			
Company Name _____			
Industry _____			
Name _____		Title _____	
Street Address _____			
City _____	State _____	Postal Code _____	Country _____
Telephone _____	Fax _____	E-mail _____	Web Address _____
Number of pumps in facility? _____		Number of Wilden pumps? _____	
Types of pumps in facility (check all that apply): <input type="checkbox"/> Diaphragm <input type="checkbox"/> Centrifugal <input type="checkbox"/> Gear <input type="checkbox"/> Submersible <input type="checkbox"/> Lobe			
<input type="checkbox"/> Other _____			
Media being pumped? _____			
How did you hear of Wilden Pump? <input type="checkbox"/> Trade Journal <input type="checkbox"/> Trade Show <input type="checkbox"/> Internet/E-mail <input type="checkbox"/> Distributor			
<input type="checkbox"/> Other _____			

**ONCE COMPLETE, FAX TO (909) 783-3440**

NOTE: WARRANTY VOID IF PAGE IS NOT FAXED TO WILDEN  
WILDEN PUMP & ENGINEERING, LLC